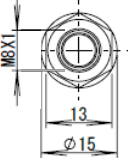
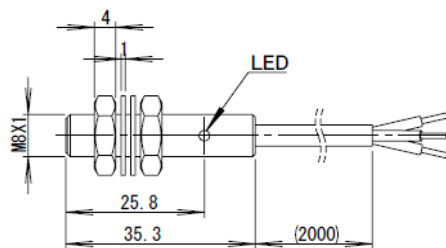
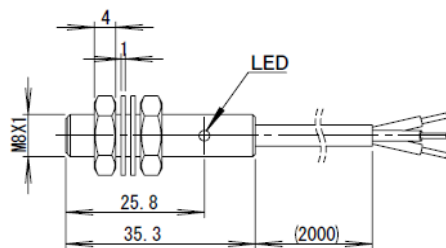
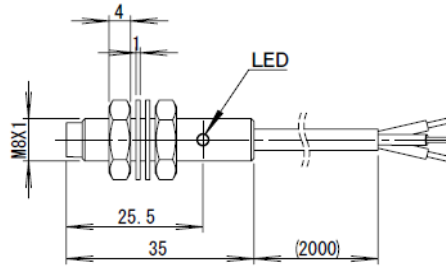
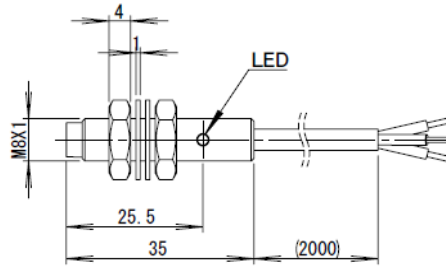
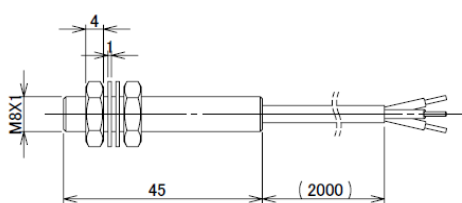
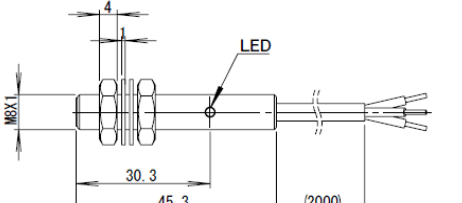
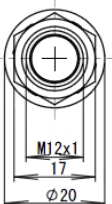
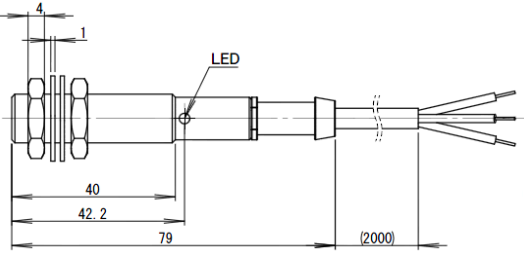
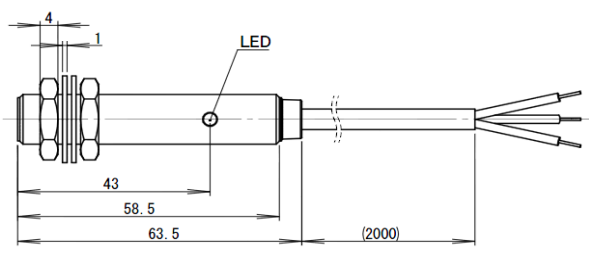
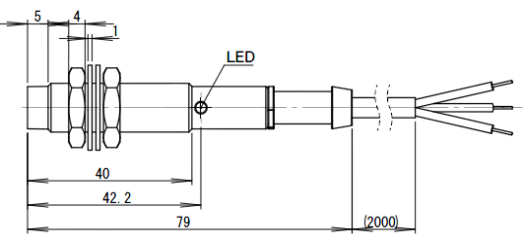
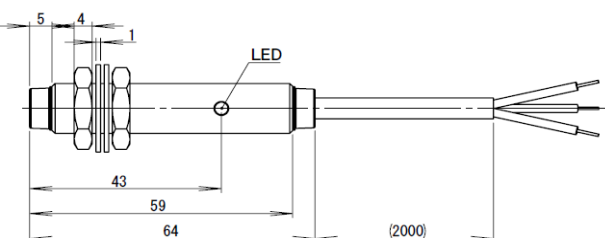
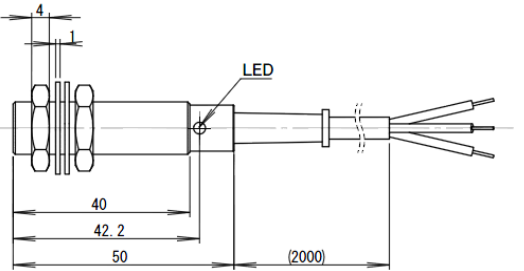
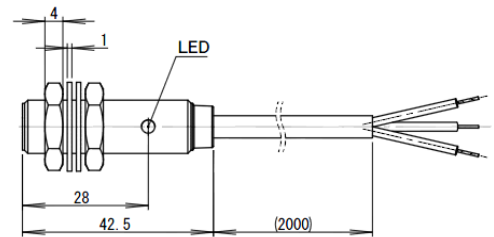
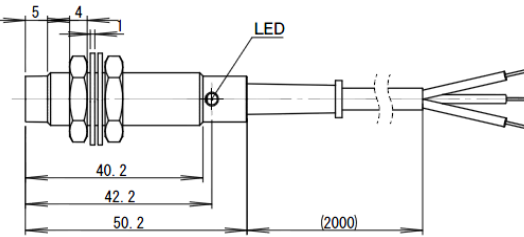
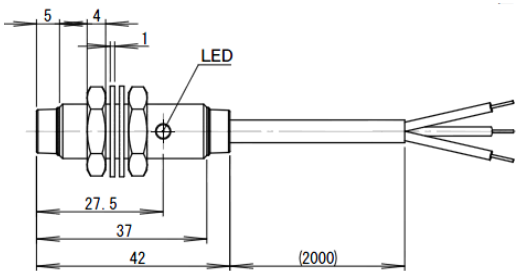

形状比較表

近接センサ型式統合 形状比較 / M8

サイズ:M8	廃止製品 <E3L・EOX>	継続製品 <E3R・E5R>
	<p>BES516 324E3L BES516 343E3L BES516 378E3L</p> 	<p>BES516 324E3R BES516 343E3R BES516 378E3R</p> 
	<p>BES516 383E3L</p> 	<p>BES516 383E3R</p> 
	<p>BES516 324EOX BES516 343EOX BES516 377EOX BES516 378EOX</p> 	<p>BES516 324E5R BES516 343E5R BES516 377E5R BES516 378E5R</p> 

近接センサ型式統合 形状比較 / M12

サイズ:M12	廃止製品 <AOL・AOZ・DOL・DOY・DOZ>	継続製品 <E3R・E5R>
	<p>BES516 325AOL BES516 329AOL BES516 370AOZ BES516 375AOL</p> 	<p>BES516 325E5R BES516 329E5R BES516 370E5R BES516 375E5R</p> 
	<p>BES516 356AOL BES516 357AOL</p> 	<p>BES516 356E5R BES516 357E5R</p> 
	<p>BES516 325DOL BES516 329DOL BES516 370DOZ BES516 375DOY</p> 	<p>BES516 325E3R BES516 329E3R BES516 370E3R BES516 375E3R</p> 
	<p>BES516 356DOL BES516 357DOL</p> 	<p>BES516 356E3R BES516 357E3R</p> 

近接センサ生産中止製品 / M16

生産中止

BES516 355AOX

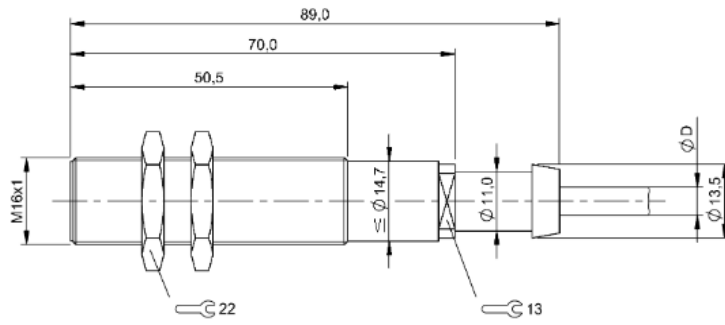

形状: M16X1 / シールド
定格検出距離: 4mm
電源電圧: 10 - 30V DC
出力タイプ: PNP N.O.